



Installation and Instruction Manual

Cascade System

Model LT199NXX1 / LT199PXX1
RTGS199N1 / RTGS199X1

FOR YOUR SAFETY: This product must be installed and serviced by a professional service technician, qualified in hot water heater installation and maintenance. Improper installation and/or operation could create carbon monoxide gas in flue gases which could cause serious injury, property damage, or death. Improper installation and/or operation will void the warranty.

⚠ WARNING

If the information in this manual is not followed exactly, a fire or explosion may result causing property damage, personal injury or loss of life.

Do not store or use gasoline or other flammable vapors and liquids in the vicinity of this or any other appliance.

WHAT TO DO IF YOU SMELL GAS

- Do not try to light any appliance.
- Do not touch any electrical switch; do not use any phone in your building.
- Immediately call your gas supplier from a nearby phone. Follow the gas supplier's instructions.
- If you cannot reach your gas supplier, call the fire department.

Installation and service must be performed by a qualified installer, service agency, or gas supplier.

⚠ AVERTISSEMENT

Assurez-vous de bien suivre les instructions données dans cette notice pour réduire au minimum le risque d'incendie ou d'explosion ou pour éviter tout dommage matériel, toute blessure ou la mort.

Ne pas entreposer ni utiliser d'essence ou ni d'autres vapeurs ou liquides inflammables dans le à proximité de cet appareil ou de tout autre appareil.

QUE FAIRE SI VOUS SENTEZ UNE ODEUR DE GAZ:

- Ne pas tenter d'allumer d'appareils.
- Ne touchez à aucun interrupteur. Ne pas vous servir des téléphones dans le bâtiment où vous vous trouvez.
- Appelez immédiatement votre fournisseur de gaz depuis un voisin. Suivez les instructions du fournisseur.
- Si vous ne pouvez rejoindre le fournisseur de gaz, appelez le service des incendies.

L'installation et l'entretien doivent être assurés par un installateur ou un service d'entretien qualifié ou par le fournisseur de gaz.

Table of Contents

SECTION 1

Piping

- A. General Plumbing Connection Guidelines ... 3
- B. Install a Backflow Preventer 3
- C. Piping Diagrams for Cascaded Systems... 3-6

SECTION 2

Electrical

- A. Wiring Connections for Cascade 7

SECTION 3

The Control Display

- A. The Control Display 8
- B. The Display 9
- C. Start Up Sequence 9
- D. Changing the DHW Set-Point 10

SECTION 4

Cascade Programming

- A. Programming the Leader 12
- B. Programming the Followers 13
- C. Setting the Vent..... 14
- D. Load Transition Graphs 15

C. Piping Diagrams for Cascaded Systems (continued)

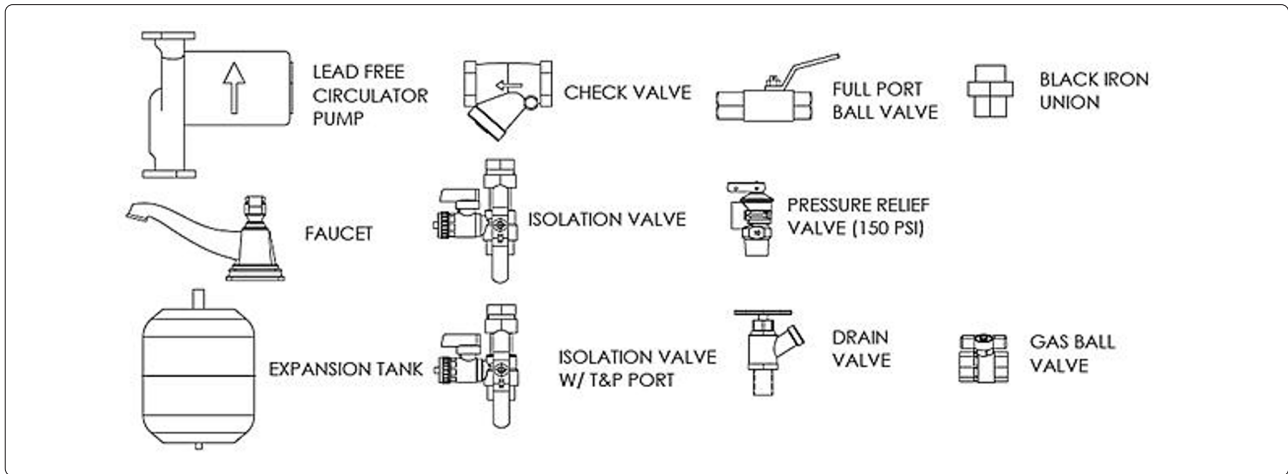

Piping Symbol Legend

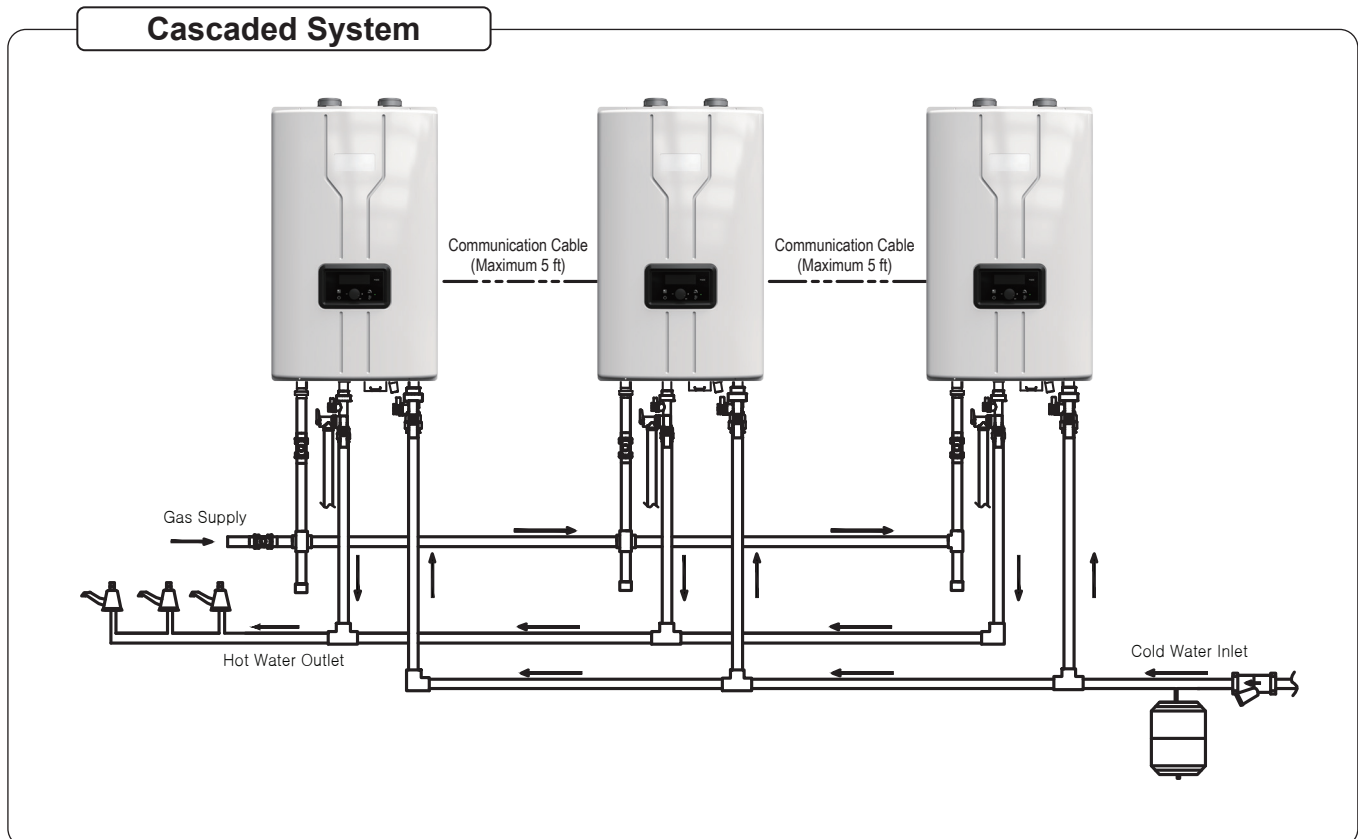

Cascaded System - Recirculation

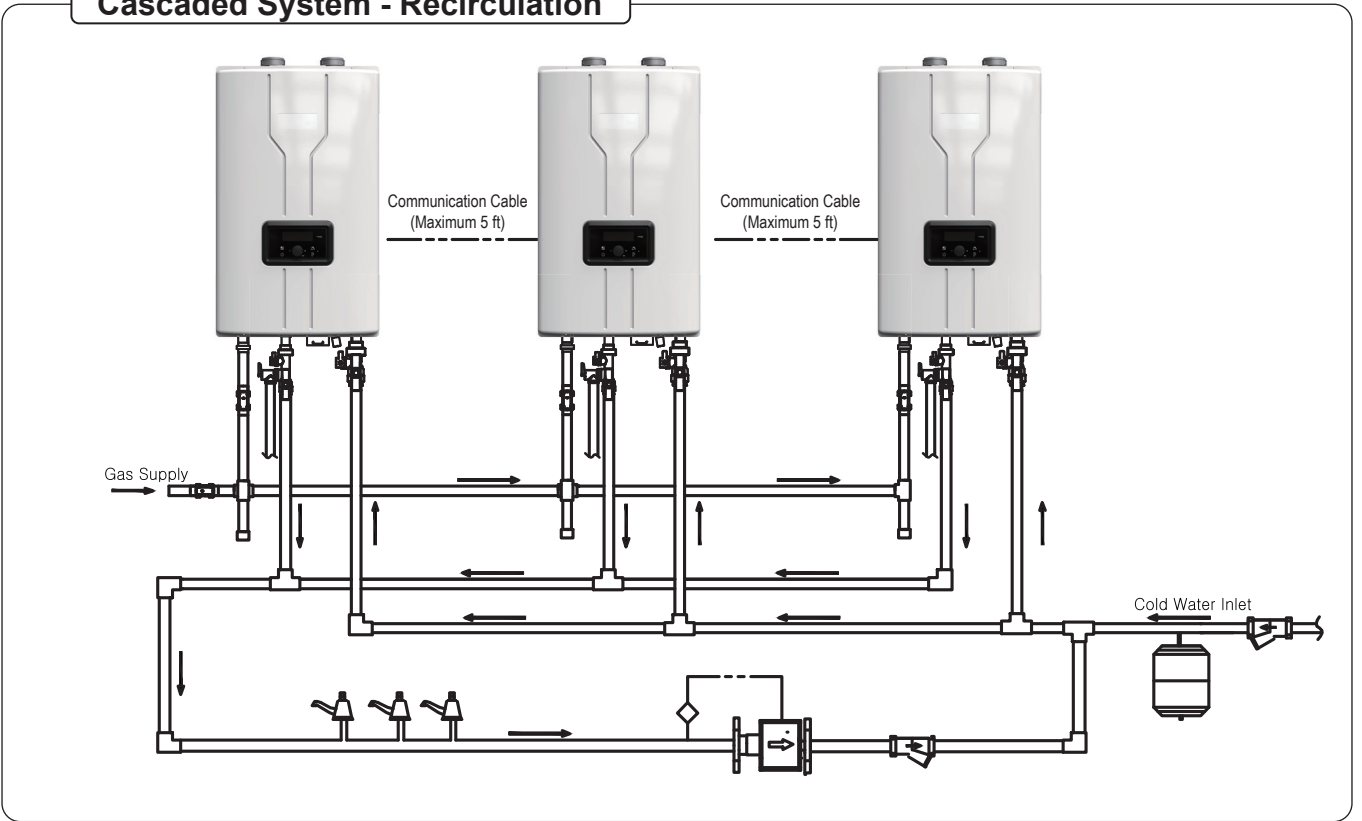

Cascaded System with Storage Tank

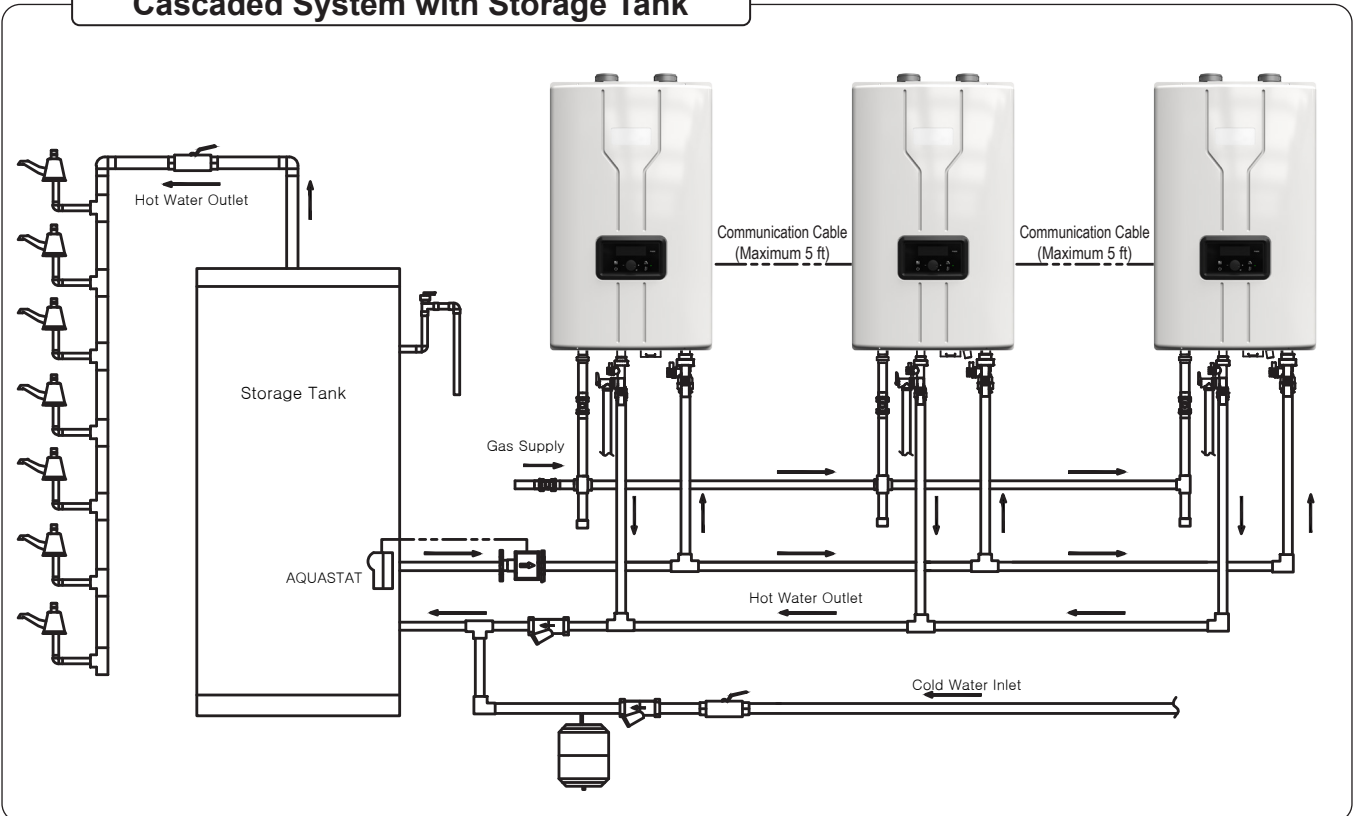

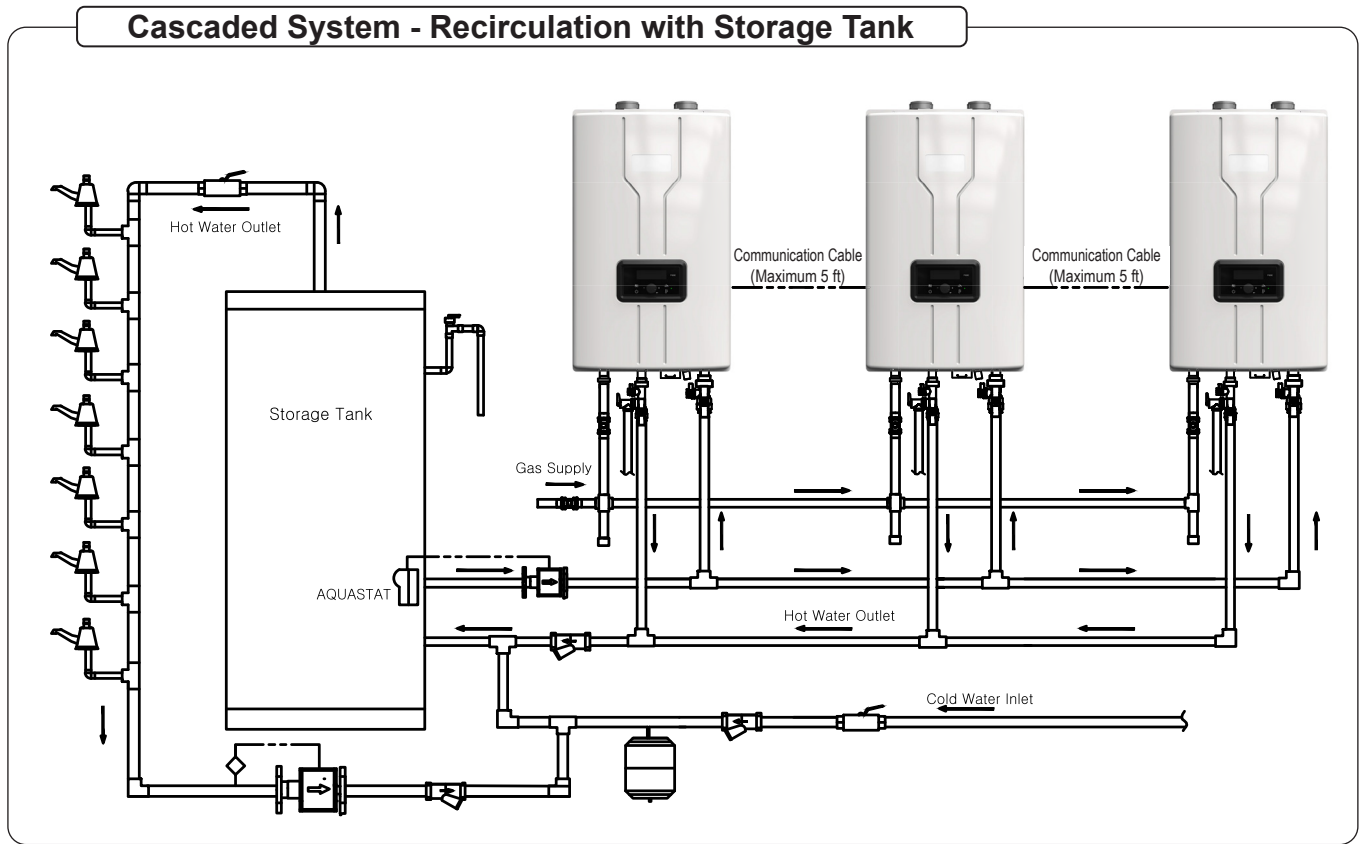

SECTION 2 Electrical

A. Wiring Connections for Cascade.

Components Needed :

FT1861: (1 per unit) Cascade Communication Cable with Ending Resistor.

Example. If you are cascading 6 tankless units, you will need **6 X communication cables** and you will only need one of the included ending resistors.

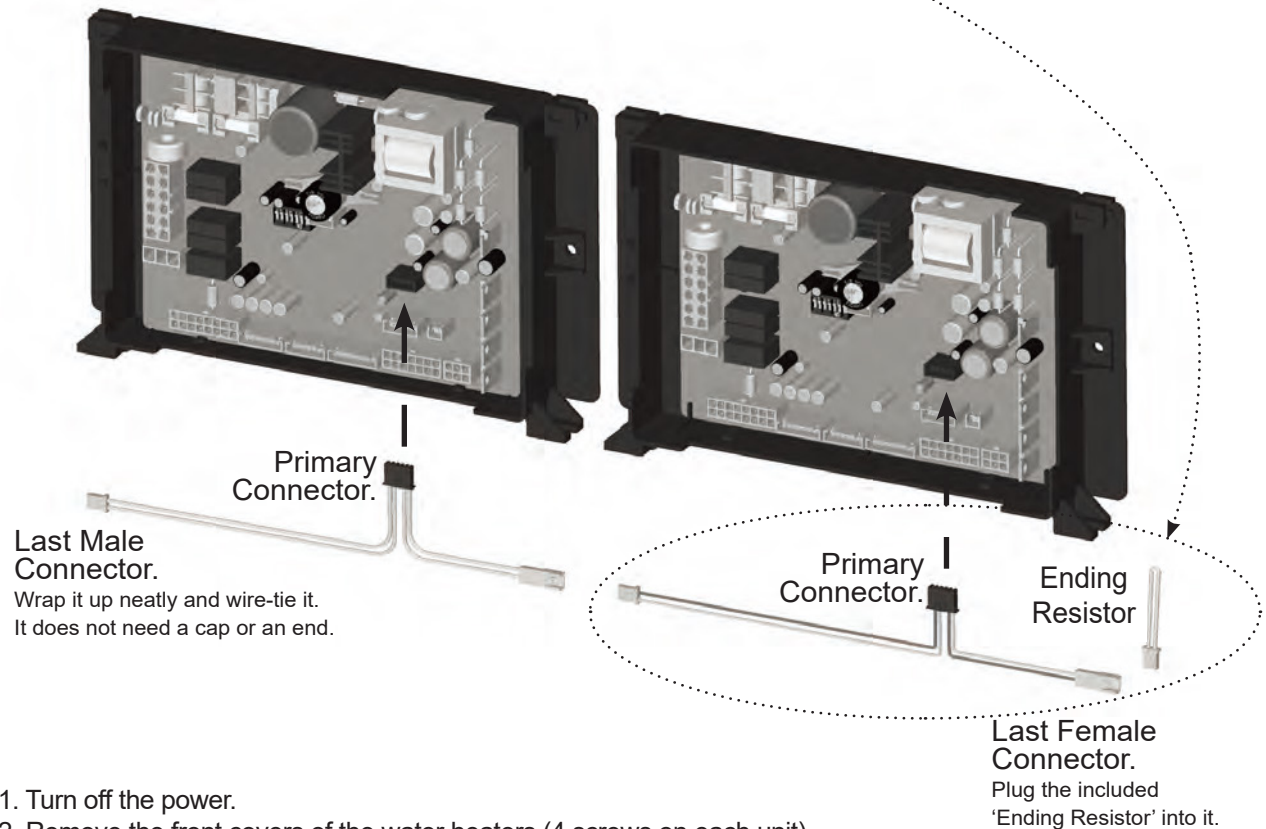

1. Turn off the power.
2. Remove the front covers of the water heaters (4 screws on each unit).
3. Connect the 'Cascade Communication Cables' to every unit (add the Resistor to the end of the last follower. Use the wiring throughway at the bottom of each unit.



4. Plug the primary connector on the cable (as shown) to the receptacle inside the unit.
5. Replace the front covers.
6. Turn on the power.

SECTION 3 The Control Display

- A. **The Control Display** has a Control Dial, 4 buttons, and a Display. Section 3 will outline how to cascade. For all functions, please reference the Installation and Instruction Manual.

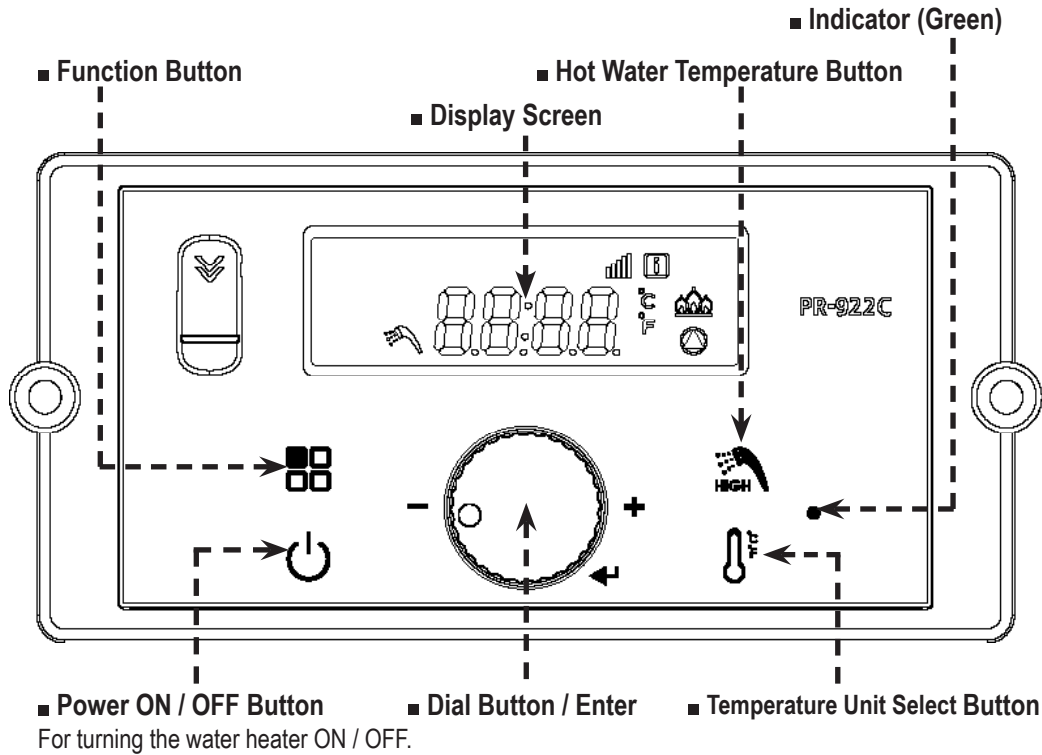

Buttons		Functionalities	
		PRESS (Tap)	PRESS and HOLD (5 seconds)
Power		Turns Control Display ON / OFF	N/A
Modes		Tap to return to menu	(If Display Power was On) Status Display Mode (If Display Power was Off) Installer Mode
Hot Water		DHW Set-Point LOW Range 95 - 120°F (35 - 49°C)	DHW Set-Point HIGH Range 121-140°F(49.5-60°C) >140°F(60°C) only accessible when using high temp vent see section 3.D
Unit			Toggle (°C, Liter ↔ °F, Gallon)
Scroll / Select		Turn to scroll, tap to select (clockwise or counterclockwise)	N/A

B. The Display

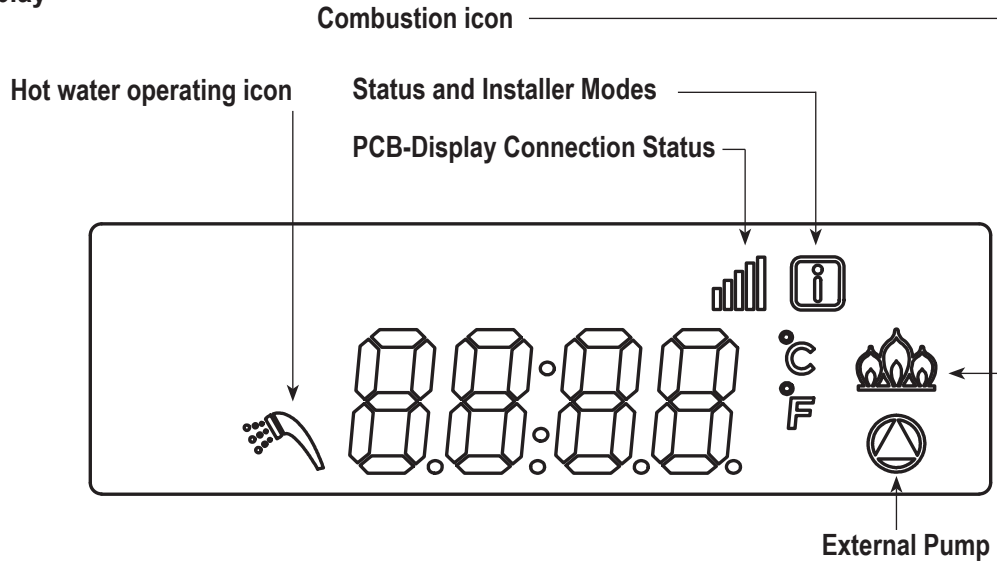



Communicating	Communication icon
Status and Installer mode	The Status Mode or the Installer Mode is Active (all parameters)
Flame Signal	Flame Signal icon
Numeric Display	Number and character display, to display all parameters
DHW Mode	Water heater Set Point, can be adjusted
External Pump	External Pump Signal icon

The LCD will illuminate when a user action is detected (a button is pressed) and will turn back off after 20 seconds.

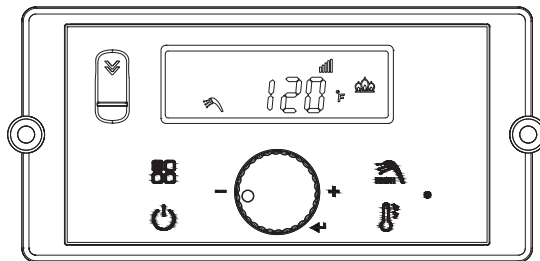
C. Start-Up Sequence. After the Power is turned on, and/or the Control Display is turned on , the Control Display will go through a 'Start Up' checklist and briefly show a sequence of diagnostic codes before entering into the 'Operating Mode'. It will then display the following information.



Indicate	Example
Target DHW temperature	120
If the flow is present	
If flame detected	
Temperature sign Celsius or Fahrenheit letter	°C °F
Main PCB to Display Connection State (If symbol is shown connection status is connected)	

D. Changing the DHW Set-Point

The tankless water heater has a built in water flow meter* and will automatically adjust the flow rate up or down based on outlet temperature at the inlet side of the water heater. If the temperature drops below the setpoint, and the water heater is at full fire, the inlet flow to the heat exchanger will be reduced. Therefore, the outlet temperature will begin to rise to the desired setpoint. If the temperature begins to rise above the setpoint the flow will increase until full flow is reached. This feature ensures that the outlet water is always the ideal temperature for the user.

If this feature is not desired, then the 'over-ride' to this feature must be turned ON.

1. Turn off the power to the Control Display.
2. Move DIP switch 4 to the ON Position.

*The Flow limiter must be active in cascaded systems to allow the leader to take priority. Otherwise demand priority will not be shared by all units evenly.

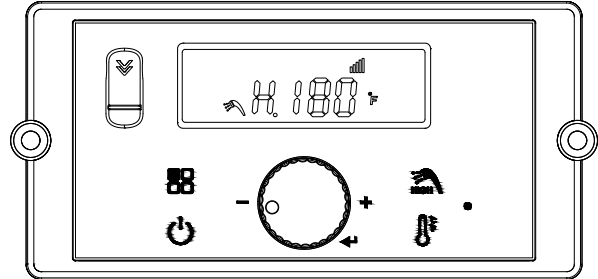
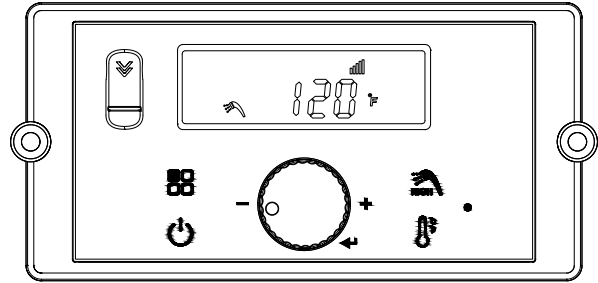

■ DHW Set Point Change Modes



The display shows the following information when changing water heating temperature set points.

Indicate	Example
Target DHW temperature	120°F
When changing DHW setpoint, the DHW icon will flash	
When DHW set-point range is high : from 125°F (51.5°C) to 180°F (82.0°C)	H. 180
Temperature sign Celsius or Fahrenheit letter	°F °C
If water heater display is communicating with the main Controller normally, the communication icon will be indicated.	

* Default set-point is 120°F (49°C)

To change between Celsius and Fahrenheit, press the button  for more than 5 seconds and temperature unit will toggle between °C and °F.

- **Hot Water Temperature Range** (Setting the water temperature to >140°F (60°C) will convert the unit into a commercial unit and the commercial warranty will apply.)

Vent Type(16:UL)	PUC	CPUC
Press the  Button	95 ~ 120°F (35 ~ 49°C)	95 ~ 120°F (35 ~ 49°C)
Press and hold the  Button	125 ~ 140°F (51.5 ~ 60°C)	125 ~ 180°F (51.5 ~ 82°C)

 DANGER

Scalding may occur within 5 seconds at a setting of 140°F (60°C). Water temperatures over 125°F can cause severe burns, or death from scalding. Children, disabled, and elderly are at highest risk of being scalded. Read all instructions before setting temperature at appliance. Feel water before bathing or showering.



SECTION 4 Cascade Programming



A. To Program the Tankless Water Heater Leader:

Once all of the 'Connection Wires' are made and all units are powered on, there are 3 items that need to be programmed on the leader before moving on to the follower units.

13:cn – **(NUMBER of THAT UNIT)** Sets Cascade Address. The Leader should always be addressed 01.

14:cl - Minimum number of operations.

15:Eh - Common Vent Setting

1. **START** by turning OFF the Power  to the Display Control of the LEAD Unit.
2. Then, with the display OFF, Press and HOLD (5 seconds) the  button to get into the Installer Mode.

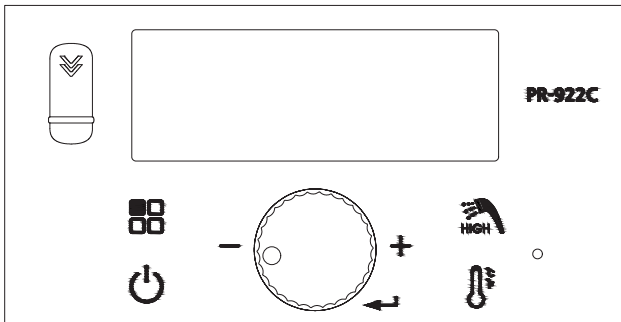

3. Rotate the Dial until you get to 13:cn. Tap the Dial to enter into that Parameter.

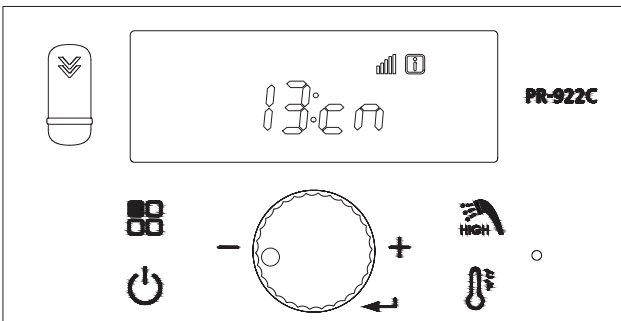

4. Adjust to 01 and then press (tap) the Dial to save and to Exit.

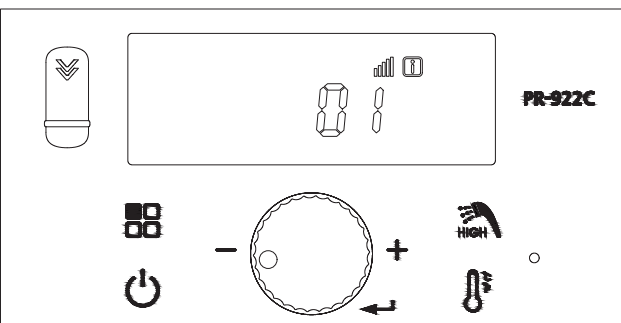

5. Rotate the Dial until you get to 14:cl. Tap the Dial to enter into that Parameter.

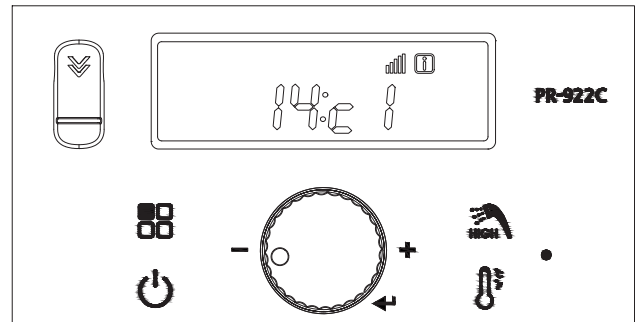

6. After adjusting the minimum number of operating water heaters, press the dial to save and finish.
(The number of operating water heaters should always be lower than the total number of installed water heaters.)

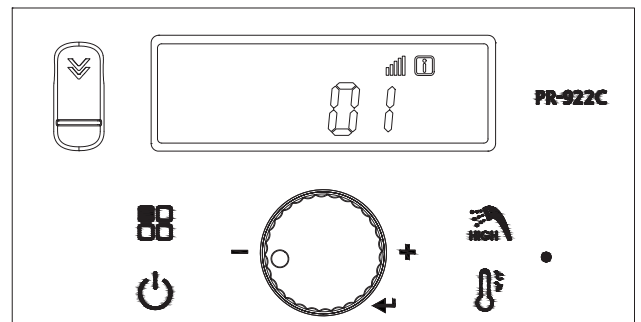

7. Rotate the Dial until you get to 15:Eh. Tap the Dial to enter into that Parameter.

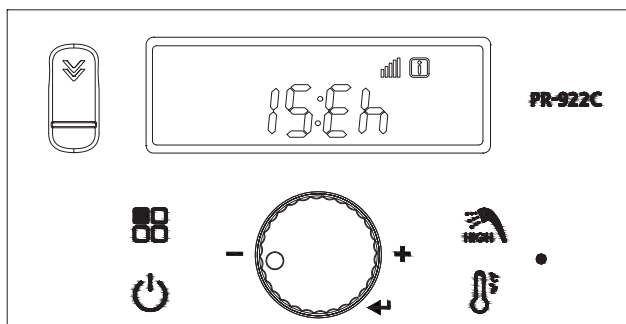

8. Select OFF and press the dial to save and finish

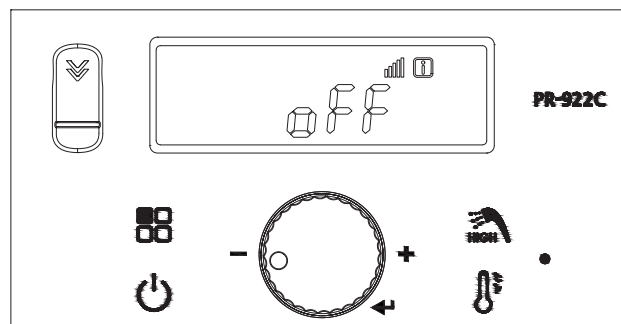

9. Finish by pressing the  button.

B. To Program the Tankless Water heater Followers:

Now move over to the first 'Following' unit and perform only 13:cn – (**NUMBER of THAT UNIT**) to each of the following units.

13:cn - (**NUMBER of THAT UNIT**) Sets the cascade address for each follower (repeat this step for all followers). Range 02 - 16, by selecting Cn:02 through cn:16

1. Rotate the Dial back to 13:cn. Tap the Dial to enter into that Parameter.

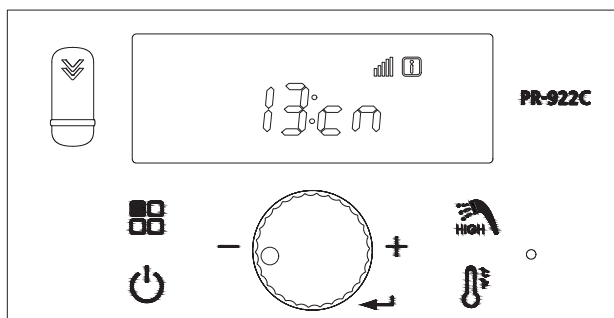

2. Adjust to each following unit number.

If you make a mistake in this setting mode, the LCD will show a "78" error code.

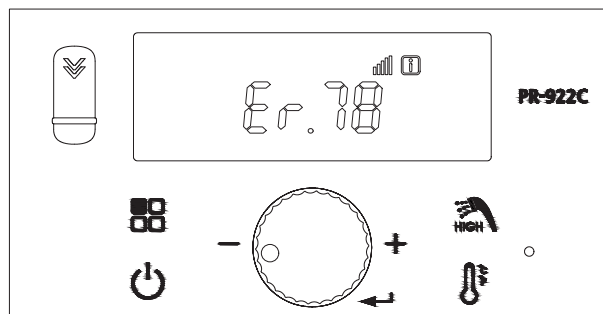

C. Setting the Vent

1. Turn OFF the Power to the Display Control
2. Then, with the display OFF. Press and HOLD the button to get into the Installer Mode.

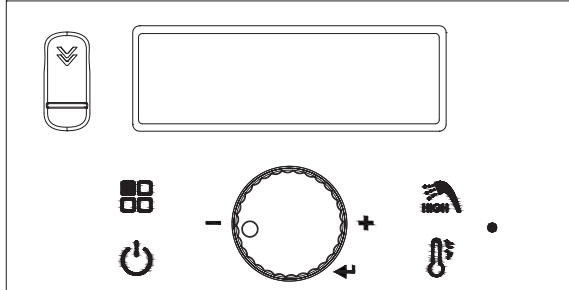

3. Rotate the Dial until you get to 16:Vt Tap the Dial to enter into that Parameter.

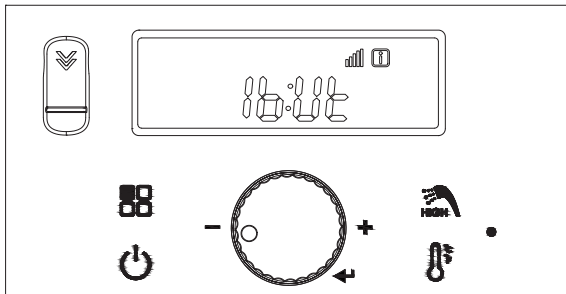

4. Turn the Dial to select either PVC or CPVC.

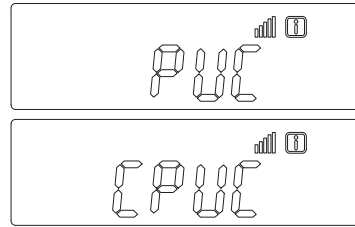

■ High Hot Water Temperature Range

Item	Vent Type	Setpoint Range(°F)
16:Vt	PVC (Standard Temperature Vent)	95 ~ 140
	CPVC, Polypropylene, Stainless Steel (High Temperature Vent)	95 ~ 180

5. If you have CPVC, Polypropylene, stainless steel or other high temp vent material, set to CPVC and then you can also set to hot water range at 125°F~180°F. If you are not positive as to the type of venting, leave it at the default setting of PVC.

6. Finish by pressing the  button.

CAUTION

- Be cautious when setting hot water temp as there is possible scald injury.
- Manufacturer is not responsible for any damage caused by scale build up from hot temperatures (over 140°F), which might cause malfunction or performance degradation
- If you set high temp (over 140°F) , vent type must be checked prior to installation .

D. Load Transition Charts

Follower Rotation Example, Five Unit Cascade System enter into that Parameter.

Cascade Transition - Single Unit Fired Up to Maximum Number of Units

Percent Firing Rate per Transition										
	Transition 1		Transition 2		Transition 3		Transition 4		Transition 5	
	Low	High	Low	High	Low	High	Low	High	Low	High
UNIT 1	0%	76%	38%	76%	51%	76%	57%	76%	61%	100%
UNIT 2	-	-	38%	76%	51%	76%	57%	76%	61%	100%
UNIT 3	-	-	-	-	51%	76%	57%	76%	61%	100%
UNIT 4	-	-	-	-	-	-	57%	76%	61%	100%
UNIT 5	-	-	-	-	-	-	-	-	61%	100%

Note: When each transition reaches 76% of firing capacity the next unit in rotation fires and the load is divided evenly amongst the firing units.

Cascade Transition - Maximum Number of Units Fired Down to Single Unit

Percent Firing Rate per Transition										
	Transition 1		Transition 2		Transition 3		Transition 4		Transition 5	
	High	Low	High	Low	High	Low	High	Low	High	Low
UNIT 1	100%	32%	40%	32%	43%	32%	48%	32%	64%	0%
UNIT 2	100%	32%	40%	32%	43%	32%	48%	32%	-	-
UNIT 3	100%	32%	40%	32%	43%	32%	-	-	-	-
UNIT 4	100%	32%	40%	32%	-	-	-	-	-	-
UNIT 5	100%	32%	-	-	-	-	-	-	-	-

Note: As each transition drops to between 20% to 32% of firing capacity the last unit in rotation drops off and the load is divided evenly amongst the remaining firing units.

